







# Programmable Logic Controller Instruction Sheet

## DVP-SS

### 1 WARNING

-  Please carefully read this manual thoroughly prior to use the DVP PLC.
-  The AC input power must be disconnected before any maintenance.
-  This is an OPEN-TYPE built-in PLC, and the PLC is certified to meet the safety requirements of IEC 61131-2 (UL 508) when installed in the enclosure to avoid high temperature, high humidity, excessive vibration, corrosive gases, liquids, airborne dust or metallic particles. Also, it is equipped with protective methods such as some special tool or key to open the enclosure, to avoid the possible hazard to users or any damage to the PLC.
-  Do not connect the AC power to any of the input/output terminals, as it might cause damage to the PLC. Make sure that all the wiring is well conducted prior to power on. Do NOT touch terminals when power on.
-  Do not touch the internal circuit for at least 1 minute after the power supply is OFF.
-  Make sure that the PLC is properly grounded (⊕), to avoid any electromagnetic noise.

### 2 INTRODUCTION

#### 2.1 Model Explanation and Peripherals

Thank you for choosing DELTA's DVP PLC Series. The DVP-SS series provides a 14-point Main Processing Unit and allows to expand units with 8~16 points. The maximum input/output points could be extended up to 128 points. Since the power supply unit is independent of the main unit, and with the volume of the device being smaller, the installation of DVP PLC is thus easier.

#### ■ Nameplate Explanation

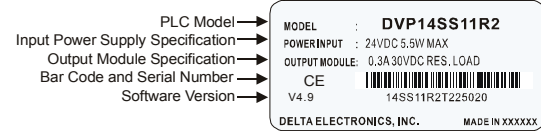

#### ■ Model Explanation

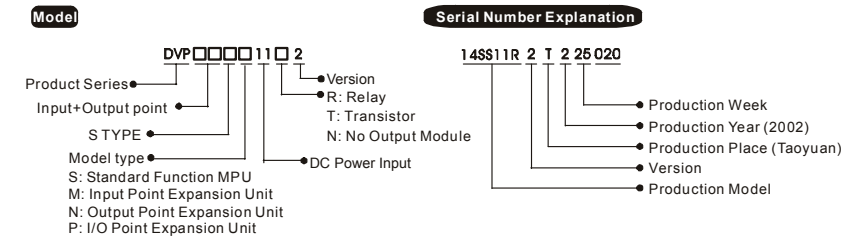

#### ■ Periphery Equipment

- ⊙ DVPHPP Handheld Programming Panel
- ⊙ WPLSoft (WINDOWS) Ladder Diagram Editor
- ⊙ DVPACAB115 Cable (HPP ↔ PLC, 1.5m)
- ⊙ DVPACAB215 Cable (PC ↔ PLC, 1.5m)
- ⊙ DVPACAB230 Cable (PC ↔ PLC/3 公尺), DVPACAB2A30 Cable (PC ↔ PLC/3 公尺)
- ⊙ DVPACAB315 Cable (HPP ↔ PC, 1.5m)

#### 2.2 Product Profile and Outline

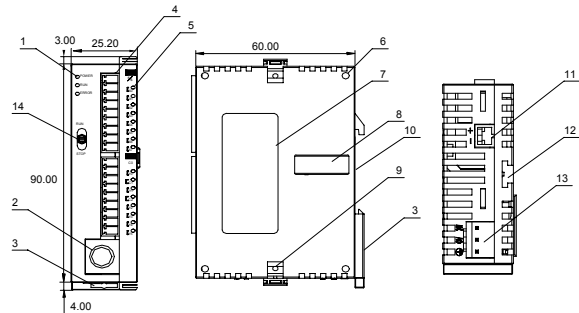

1. Status indicator (Power, RUN and ERROR)	8. Extension port
2. I/O port for program communication (RS-232)	9. Extension unit clip
3. DIN rail clip	10. DIN rail (35mm)
4. I/O terminals	11. RS-485 Communication port
5. I/O point indicator	12. Mounting rail of the extension unit
6. Mounting hole of the extension unit	13. DC Power input
7. Nameplate	14. RUN/STOP switch

#### 2.3 Model Numbers

##### ⊙ Standard Function MPU

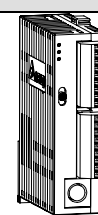
Model	Power	Input/Output		Output Unit		Profile Reference
		Point	Type	Point	Type	
DVP14SS11R2	24VDC	8	DC Type Sink or Source	6	Relay	
DVP14SS11T2		8		6	Transistor	

##### ⊙ Digital I/O Extension Unit

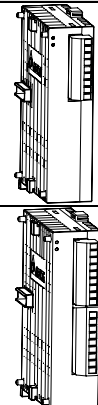
Model	Power	Input/Output		Output Unit		Profile Reference
		Point	Type	Point	Type	
DVP08SM11N	24VDC	8	DC Type Sink or Source	0	None	
DVP08SN11R		0		8	Relay	
DVP08SN11T		0		8	Transistor	
DVP08SP11R		4		4	Relay	
DVP08SP11T		4		4	Transistor	
DVP16SP11R		8		8	Relay	
DVP16SP11T		8		8	Transistor	

##### ⊙ Analog/temperature module extension unit

Please refer to user manuals that go with PLC.

##### ⊙ Power Supply Module

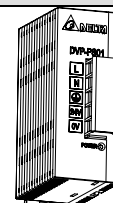
Model	Input/Output		Profile Reference
	Input Power	Output Power	
DVPPS01	100~240VAC (50/60Hz)	Output voltage: 24VDC Output current (max.): 1A	
DVPPS02	100~240VAC (50/60Hz)	Output voltage: 24VDC Output current (max.): 2A	

### 3 STANDARD SPECIFICATIONS

#### 3.1 Function Specifications

Item	Specification	Remark	
Control Method	Stored program, cyclic scan system		
I/O Processing Method	Batch I/O (refresh)	Immediate refresh command available only with I/O of the MPU	
Execution Speed	Basic command (several μs)	Application command (10~hundreds μs)	
Program Language	Instructions + Ladder Diagram + SFC	Step instructions included	
Program Capacity	3792 Steps	Built-in EEPROM	
Instructions	Basic commands: 32 (including the STL commands)	Application commands: 107	
Step Relay (Latched)	Primary step point	10 Points	
	General step point	118 Points	
Auxiliary Relay	General	512+232 Points	
	Latched	256 Points	
	Special	280 Points	
Timer	Digital	64 Points	
		63 Points	
		1 Point	
Counter	General	112 Points	
		Latched	16 Points
		High-Speed	13 Points 1-Phase 20KHz, 2-Phase 5KHz
Data Register	General	408 Points	
		Latched	192 Points
		Special	144 Points

Item	Specification	Remark
Pointer	P	64 Points
Index Relay	E/F	2
Constant	Decimal K	16 bit: -32768~+32767
	Hexadecimal H	16 bit: 0000~FFFF
Serial Communication Port	Program write/read communication port: RS-232C. General function communication port: RS-485 (controlled by the RS command). The DELTA's inverter-specific drive commands are included as well.	

\* Additional remark: Refer to the PLC Technique Application Manual for relevant special relays and data registers.

#### 3.2 General Specifications

Item	Model	DVPPS01	DVP14SS 11R2/T2	DVP08SM11N	DVP08SN11R/T	DVP08SP11R/T	DVP16SP11R/T
Power Supply Voltage		100~240VAC (50/60Hz)	24VDC (-15%~20%) (the counter-connection protection towards the DC input power polarity is included)				
Motion Specifications		Within 5ms of the momentary power loss, the device will keep on operating					
Capacity of the Power Supply Fuse		2A / 250VAC		---			
Power Consumption		---	3.5W	1W	1.5W	1.5W	2W
Insulation Resistance		Above 5 MΩ (500VDC between the ground and all the I/O points)					
Noise Immunity		ESD(IEC 61131-2, IEC 61000-4-2): 8KV Air Discharge EFT(IEC 61131-2, IEC 61000-4-4): Power Line: 2KV, Digital I/O: 1KV, Analog & Communication I/O: 1KV Damped-Oscillatory Wave: Power Line: 1KV, Digital I/O: 1KV RS(IEC 61131-2, IEC 61000-4-3): 26MHz~1GHz, 10V/m					
Grounding		The diameter of the grounding wire cannot be smaller than that of terminals L and N (if numerous PLCs are used at the same time, make sure that each PLC is grounded respectively to the ground poles)					
Ambient Temperature/Humidity		For operation: 0°C~55°C (temperature), 50~95% (humidity), the 2 <sup>nd</sup> degree pollution. Storage: -40°C~70°C (temperature), 5~95% (humidity)					
Vibration/Shock Immunity		International Standard Regulations: IEC1131-2, IEC 68-2-6 (TEST Fc) / IEC1131-2 & IEC 68-2-27 (TEST Ea)					
Weight (approximation)		210(g)	214(g)/208(g)	128(g)	154(g)/146(g)	141(g)/136(g)	162(g)/154(g)
Approvals							

Input Point Electric Specifications	
Input Type	DC (SINK or SOURCE)
Input Current	24VDC 5mA
Motion Level	Off-On, above 16VDC On-Off, below 14.4VDC
Responding Time	About 10ms (An adjustment range of 0~20ms could be selected through D1020 and D1021)

Output Point Electric Specifications		
Output Type	Relay-R	Transistor-T
Current Specifications	1.5A/1 point (5A/COM)	55°C 0.1A/1point, 50°C 0.15A/1point 45°C 0.2A/1 point, 40°C 0.3A/1 point (2A/COM)
Voltage Specifications	Below 250VAC, 30VDC	30VDC
Maximum Loading	75 VA (Inductive)	90 W (Resistive)
Responding Time	About 10 ms	9W Off-On 15us On-Off 25us

### 4 INSTALLATION & WIRING

#### 4.1 Terminal Wiring of the Standard Function MPU and the Digital I/O Extension Unit

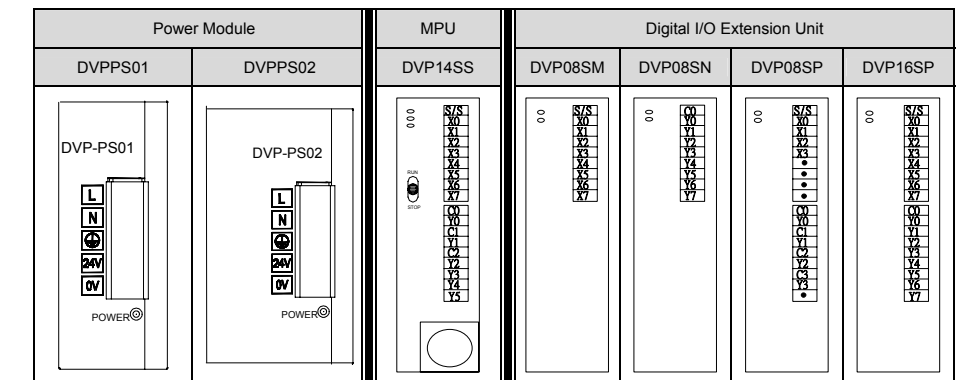

#### 4.2 Mounting Arrangements and Wiring Notes

When installing the DVP series PLC, make sure that it is installed in an enclosure with sufficient space (as shown diagram on the right) to its surroundings for heat dissipation purpose.

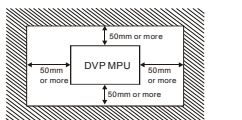

#### ■ Installation of the DIN Rail

The DVP-PLC can be secured to a cabinet by using the DIN rail. This DIN rail should be 35mm high with a depth of 7.5mm, and when mounting the PLC on the DIN rail, be sure to use the end bracket to stop any side-to-side motion of the PLC, which will reduce the chance of the wires being pulled loose. At the bottom of the PLC is a small retaining clip. To secure the PLC to the DIN rail, place it onto the rail and gently push up the clip. To remove it, pull down the retaining clip and gently pull the PLC away from the DIN rail.

#### ● Wiring

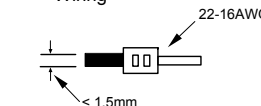

Use the 22-16AWG (1.5mm) single-core bare wire or the multi-core wire for the I/O wiring, and the specifications of the terminal are shown diagram on the left. The twisting power of the screw for the PLC terminal is 1.95 kgf-cm (1.7 lb-in). Be sure not to place power wires such as the input point signal wire and the output point wire at the same conduit or to use the same multi-core wire.

Be sure not to place power wires such as the input point signal wire and the output point wire, or the power supply, at the same conduit during wiring.  
 "Use Copper Conductors Only", 60/75°C.

● Points of Attention

Environment

1. **DO NOT** install the PLC in a dusty, smoky, or corrosive atmosphere.
2. **DO NOT** install the PLC in an environment with high temperature or high condensation.
3. **DO NOT** install the PLC in an environment with immediate vibration and shock.

Construction

1. Any accident the drop of conductive debris into the PLC during screwing and wiring has to be avoided.
2. Allow a minimum space of 50mm between PLC and other control components, and keep PLC away from the high-voltage lines or any power equipment.

4.3 Wiring and Specifications of the Power Terminals

This PLC model uses DC input power. Therefore, make sure that PLC is connected to terminals 24VDC and 0V (power range 20.4VDC~28.8VDC) when the power is ON. PLC will stop the operation and output will be OFF whenever the power input is lower than 20.4VDC. Consequently, the ERROR LED will blink swiftly.

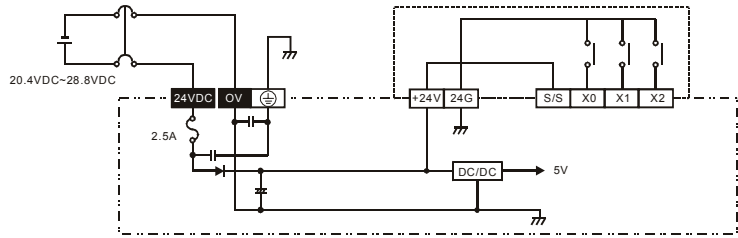

■ Safety Guidelines

Due to the PLC is used to control numerous devices, a motion in one device could affect that of other devices. Hence, the breakdown in one device would consequently a detriment to the whole auto control system, and danger or damage will be significantly. Listed below is the recommended wiring for the power input:

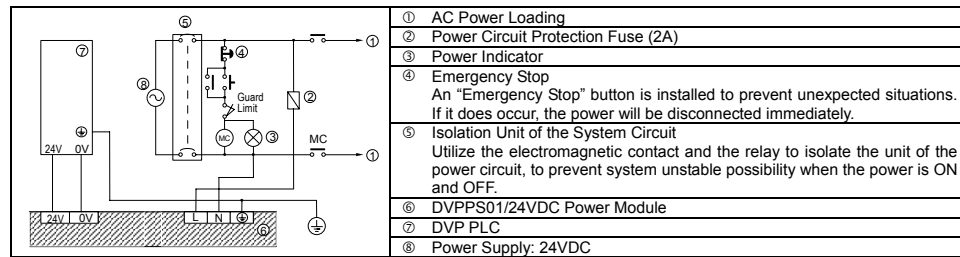

■ Wiring of the Input Point

Two types of wiring: SINK or SOURCE, depends on the way of configuration the DC input signal to the DC input power in, which are defined as follows:

- The DC Type, there are two types of wiring to the DC type: SINK and SOURCE, and they are defined as follows:

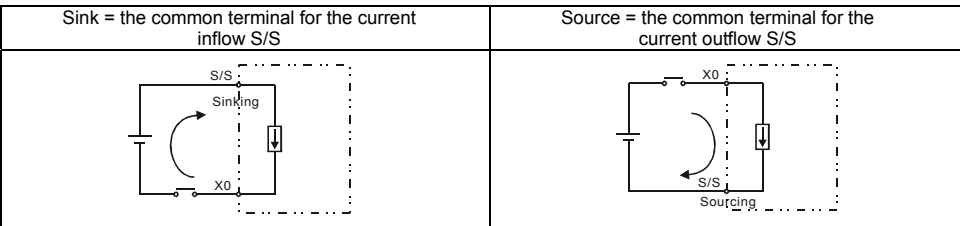

○ Wiring

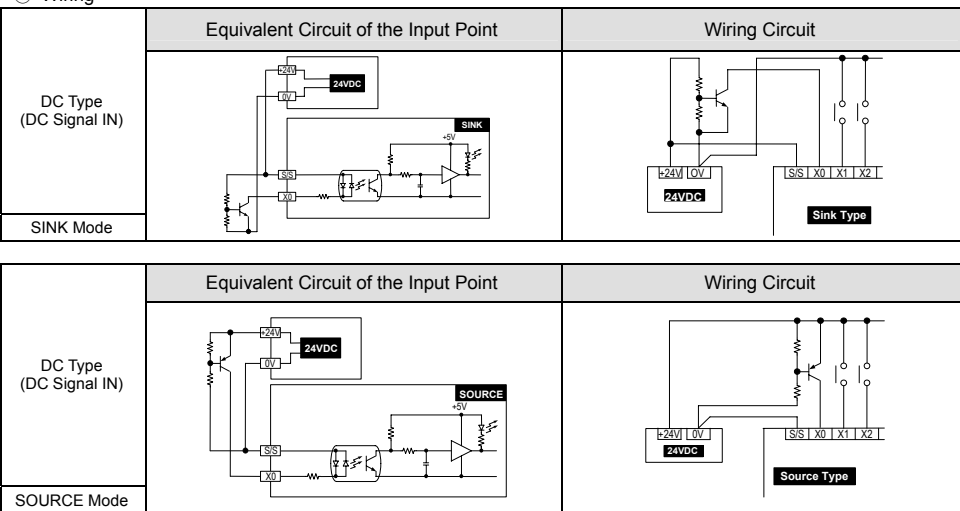

⚠ Overload Capacity of the Output Terminal

Every output contact possesses the overload capacity that is twice the rated current within 5 minutes, and as for the common contact, the overload capacity is 1.5 times the rated current within 2 minutes. And if the range is exceeded, it might result in the contact's malfunctioning, or even cause internal wire burnt. There are two types of output modules for the DVP-S Series PLC: relay or transistor. Refer to Functions & Specifications for relevant electric specifications.

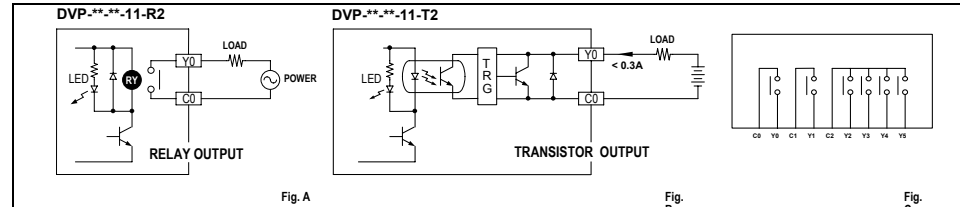

When actual wiring is conducted at the output terminal, pay special attention to the wiring at the common end. Take DVP14SS11R2 as an example, the output terminal Y0 utilizes the common end C0, and Y2 uses C1, whereas Y2~Y5 use C2, as shown in Fig. C.  
 Isolation Circuit: the photocoupler is utilized as the signal isolation between PLC internal circuit and input module.

○ The Relay Output Circuit Wiring

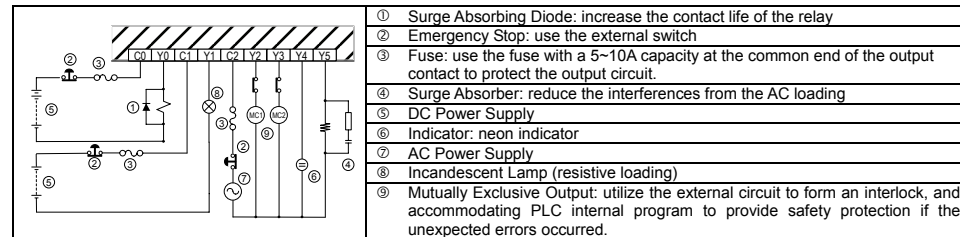

○ The Transistor Output Circuit Wiring

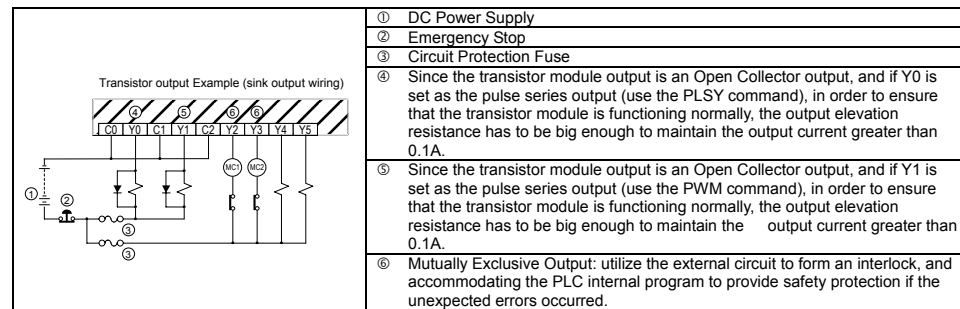

5 TRIAL RUN

■ Power Indication

1. At the front of the MPU or the expansion unit, there is a "POWER" LED. When the MPU is powered ON, the LED (in green) will be ON. If the indicator is not on when the MPU is powered up, it means there is problem that DC power supplies to PLC. Thus, it is important to check whether the wiring of +24V and 0V are properly conducted. If ERROR LED is blinking swiftly, it means +24VDC does not supply enough power to PLC.
2. If the other indicator, "L. V.", that locates at the front of the extension unit is on, it means that the input power voltage to the extension unit is insufficient, and the output from the extension unit should be prohibited.

■ Preparation

1. Make sure that the power wiring and the I/O wiring are both conducted properly before the power ON. Please ensure **NOT** supply AC110V or AC220V to the I/O terminals, or the wiring might be short circuit which would damage the PLC directly.
2. After using the peripheral devices to write the program into the MPU and that the ERROR LED of the MPU is not on, it means that the program in use is legitimate, and it is now waiting for the user to give the RUN command.
3. Use HPP to execute the forced On/Off test of the output contact.

■ Operation & Test

1. If the ERROR LED of the MPU is not blinking, use the peripheral device to give the RUN command, and the RUN indicator will then be on.
2. HPP could be utilized to monitor the settings and the registered values of the timer, the counter and the data register during operation. Also it is used to force the I/O contacts to conduct the On/Off motion. If the ERROR LED is on (but not blinking), it means that the setting of the user's program has exceeded the preset time-out limit. At this case, please turn the PLC RUN/STOP switch to STOP, and find out the address of the time-out program by special data register D1008. "WDT" instruction can be used to solve the problem.

■ The PLC I/O Response Time:

The total response time of the PLC from the input signal to the output motion is calculated as follows:

"Response Time" = "input interface delay time" + "user's program scan time" + "output motion delay time"

Input interface delay time	Factory setting: 10ms. Please refer to the usage of special registers D1020~1021.
User's program scan time	Refer to the usage on special register D1010 for detail.
Output motion delay time	The relay module is about 10ms. The transistor module is about 20~30 μs.

■ Basic Commands and Application Commands of the PLC:

- The basic commands and the application commands of the MPU of this series are totally applicable to the DELTA DVP-PLC ES Series MPU. Refer to the DELTA PLC Technique Application Manual for relevant basic commands and application commands.
- The DVPHPP hand-held programming panel, the DPLSoft (the DOS version) ladder diagram editing program or the WPLSoft (the Windows version) ladder diagram editing program are all good for use with the DELTA

DVP-PLC, also the PLC could connect with the DVP14SS MPU through specific transmission wire, and then, the program transmission, the MPU control and the program monitoring could all be executed.

6 FAULT CHECK & MAINTENANCE

6.1 Judge the Error through the Indicator at the Front Panel

When error occurred for the DVP PLC, please check:

"POWER" LED

There is a "POWER" LED at the front of the MPU. When the MPU is powered On, the green LED light will be on. If the indicator is not on when the MPU is powered up and with the input power being normal, it is an indication that the PLC is out of order. Please have this machine replaced or have it repaired at a dealer near you.

"RUN" LED

Identify the status of the PLC. When the PLC is in operation, this light will be on, and users could thus use HPP or the ladder diagram to edit program and give commands to make the PLC "RUN" or "STOP".

"ERROR" LED

1. If illegitimate program is input to the MPU, or that the commands and devices of the program exceed the allowable range, the indicator will thus be blinking. In this case, the user should inquire about the error code from the special data register D1004 in the MPU and look it up in the Error Code Table. After the error is found and the program is revised, send the revised version to the MPU.
2. If the PLC is unable to perform function, and the LED is blinking swiftly, it indicates that 24VDC power does not supply sufficient power. Please check whether the power supply of 24VDC is normal or not.
3. When the ERROR LED is on (not blinking), it is an indication that the execution time of the program circuit has exceeded the preset time-out limit (setting of D1000). To check the program circuit or use the WDT command to improve the error status. Once program modification is completed, user can re-download the program of PLC and the ERROR LED will be off. If the ERROR LED is still keep on, please turn off the power and check if there's any noise or any conductive invader inside the PLC.

"Input" LED

The On/Off signals of the input point could be displayed through the "Input" LED, or monitor the status of the input point through the device HPP monitoring function. Once the motion of the input point is valid, the LED is on. Therefore, if errors are detected via using HPP, the LED and the input signal circuits then are used to check whether the status is normal. Especially when the electronic switch of great electric leakage is utilized, the input point is usually witnessed with unexpected motions.

"Output" LED

The "Output" LED is designed mainly for display the On/Off status of the output signals. When the "Output" LED is On or Off and that the loading is of an opposite motion, the following conditions should be attended to:

1. The output contact might be melted down and blocked up due to overload or load in short-circuit, defect happened consequently under this situation.
2. If the output contact is function as undesired, be sure to check the output wiring circuit and whether the screw is tightened or not.

6.2 Error Code Table

Error Code	Explanation	Error Code	Explanation
0001	Device S exceeds the usage limit	0F05	Misused Operand DXXX of DCNT
0002	Label P has been used repetitively or exceeds the usage limit	0F06	Misused SFTR operands
0003	KnSm exceeds the usage limit	0F07	Misused SFTL operands
0102	Interrupt Pointer, I, has been used repetitively or exceeds the usage limit	0F08	Misused REF operands
0202	Instruction MC exceeds the usage limit	1000	Misused ZRST operands
0302	Instruction MCR exceeds the usage limit	C400	Illegitimate commands
0401	Device X exceeds the usage limit	C401	General circuit error
0403	KnXm exceeds the usage limit	C402	LD / LDI commands have been used for more than 9 times consecutively
0501	Device Y exceeds the usage limit	C403	MPS has been used for more than 9 times consecutively
0503	KnYm exceeds the usage limit	C404	FOR-NEXT over 6 steps and above
0601	Device T exceeds the usage limit	C405	STL/RST used between FOR-NEXT
0604	T register exceeds the usage limit		SRET/IRET used between FOR-NEXT
0801	Device M exceeds the usage limit		MC/MCR used between FOR-NEXT
0803	KnMm exceeds the usage limit		END / FEND used between FOR-NEXT
0D01	Misused DECO operands	C407	STL has been used for more than 9 times consecutively
0D02	Misused ENCO operands	C408	MC/MCR used within STL
0D03	Misused DHSCS operands		I/P used within STL
0D04	Misused DHSCR operands	C409	STL/RET used within the Subroutine
0D05	Misused PLSY operands		STL/RET used within the Interrupt Service Routine
0D06	Misused PWM operands	C40A	MC/MCR used within the Subroutine
0D07	Misused FROM/TO operands		MC/MCR used within the Interrupt Service Routine
0D08	Misused PID operands	C40B	MC/MCR does not start from N0 nor of the discontinuous status
0E01	Component C exceeds the usage limit	C40C	The relative N value of MC/MCR is different
0E04	C register exceeds the usage limit	C40D	I/P not used properly
0E05	Misused Operand CXXX of DCNT	C40E	IRET should not appear following the last FEND command.
0E18	BCD conversion error		SRET should not appear following the last FEND command
0E19	Division error (divisor=0)	C41C	I/O points of the extension unit exceed the limit.
0F04	D register exceeds the usage limit	C4EE	END command not existed within the program

6.3 Periodic Inspection

Since the DVP series PLC does not utilize disposable components, there is thus no need to replace most of the components. However, if the output relay turns on/off frequently, or drive the large load current too often, life of the output contact will thus be decreased. Under a condition like this, periodic inspection is then needed to ensure if the contact is of the "Permanently Open" status or of the short-circuit status. Moreover, the following precautions should be noted:

1. Do not mount the DVP under direct sunlight or near any heat-radiation objects.
2. Do not install the DVP-PLC in places subject to high temperature, high humidity, excessive vibration, corrosive gasses, liquids, airborne dust and metallic particles.
3. Check periodically whether the wiring and terminals are tightened and conducted properly.